



YEKSAN

LEVELING SYSTEM



PRODUCTS OF THE SAME COMPANY LULING



Clips and Wedges

Clips are made of high quality material, which allows clips to be highly resistant to traction so that heavy pieces can be adjusted fast and effectively. Clips have side cuts (patented), which allow us to remove them easily, just with a knock on the side in the joint direction, when the work is finished (mortar setting).

Ref.	Description	mm(in)	Units	Bags (per box)	Box (cm)	Weight (kg)
 Ma00101	ECO Clip Tile thickness with 4 to 16 mm	1[1.32"]	100	36	55×32×48	7.850
 A00110	Clip Tile thickness with 4 to 16 mm	1[1.32"]	100	36	55×32×48	8.890
 M0092	Clip Tile thickness with 4 to 16 mm	1[1.32"]	100	36	55×32×48	9.250
 Am00202	Special Clip	1[1.32"]	100	36	55×32×48	7.665
 Am00203	Eco Clip	1[1.32"]	100	36	55×32×48	8.100
 C00213	Clip Tile thickness with 4 to 16 mm	1/5[3.64"]	100	36	55×32×48	10
 F00135	Clip Tile thickness with 4 to 16 mm	2[1.16"]	100	36	55×32×48	11.625
 Y00431	Clip for stone Tile thickness with 16 to 30 mm	1[1.32"]	100	28	55×32×48	10
 I00122	Clip Tile thickness with 4 to 16 mm	1[1.32"]	100	50	55×32×48	11.900



Clips and Wedges

Clips are made of high quality material, which allows clips to be highly resistant to traction so that heavy pieces can be adjusted fast and effectively. Clips have side cuts (patented), which allow us to remove them easily, just with a knock on the side in the joint direction, when the work is finished (mortar setting).

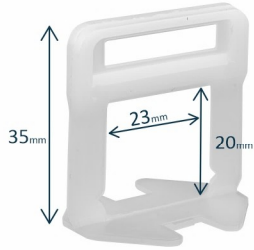

Ma00101

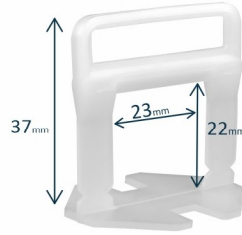

A00110



M0092

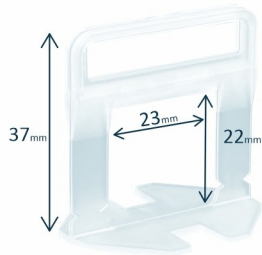

Am00202

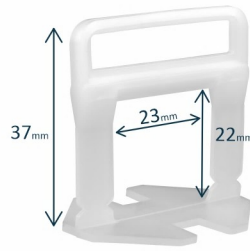

Am00203

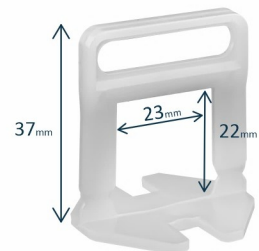

C00213

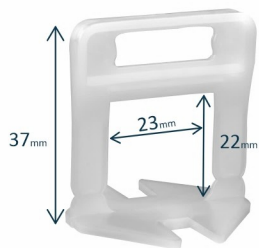

F00135

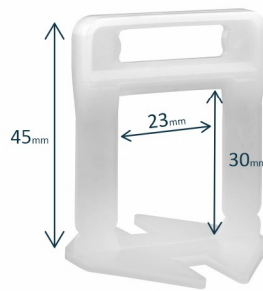







Y00431



I00122



Wedge

							
	Ref.	Description	color	Units	Bags (per box)	Box (cm)	Weight (kg)
	G00333	Eco Levelling wedge	Black	50	36	55×32×48	10
	G00444	Eco Levelling wedge	Red	50	36	55×32×48	10
	G00666	Levelling wedge	Red	50	26	55×32×48	10
	G00777	Special Levelling wedge	Red	50	25	55×32×48	11
	G00555	Small Levelling wedge Use for Small Clips(I00122)	Red	100	50	55×32×48	12.900



G00333



G00444



G00666



G00555

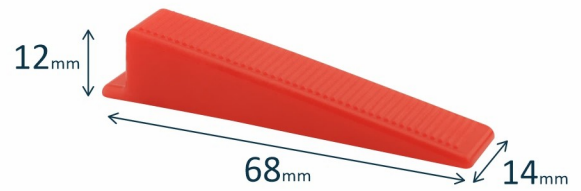





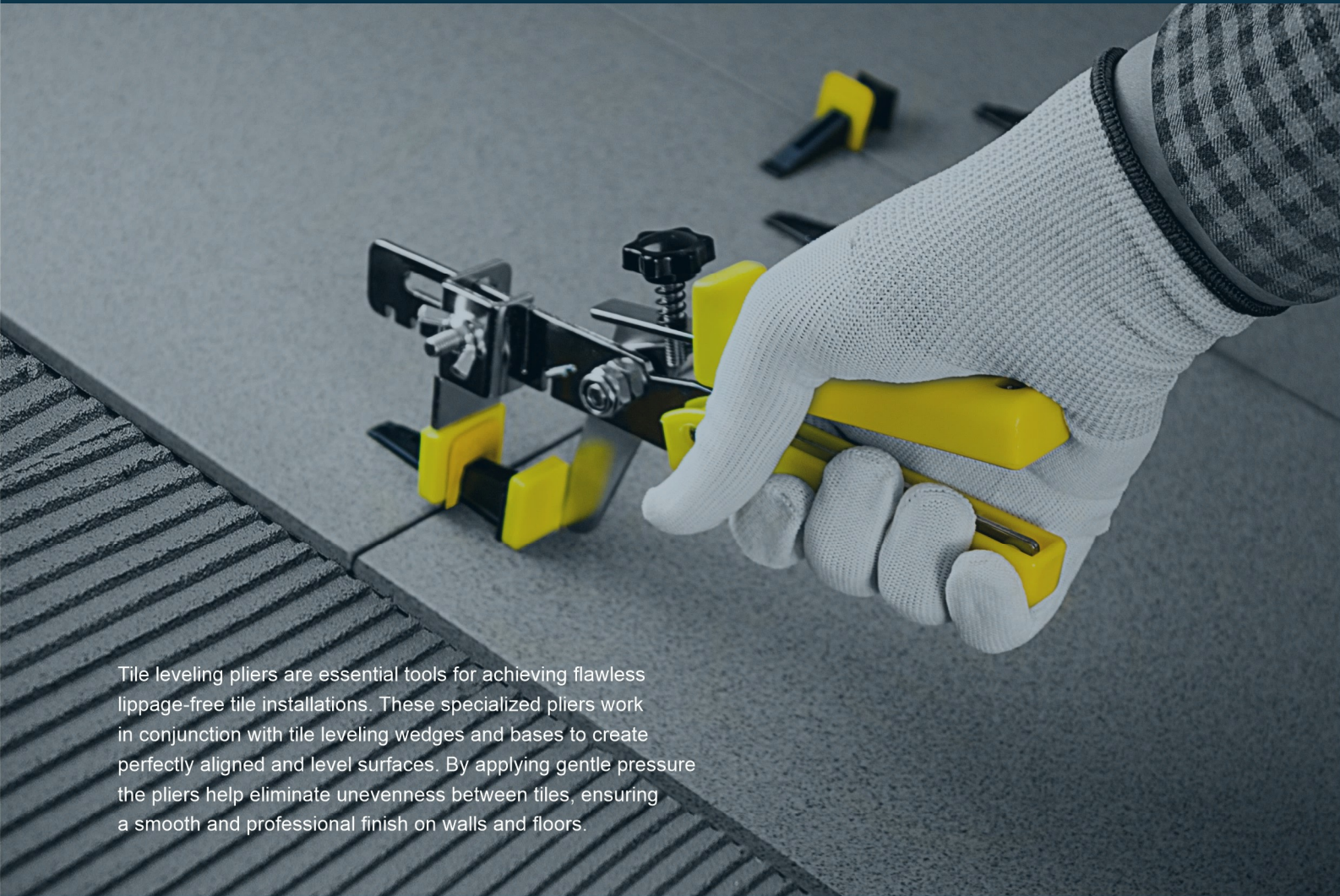



Ceramic and Stone Pliers



Tile leveling pliers are essential tools for achieving flawless lippage-free tile installations. These specialized pliers work in conjunction with tile leveling wedges and bases to create perfectly aligned and level surfaces. By applying gentle pressure the pliers help eliminate unevenness between tiles, ensuring a smooth and professional finish on walls and floors.

					
Ref.	Description	Weight	Units (per box)	Box (cm)	Weight (kg)
	ACH00777 Metal Ceramic and Stone Pliers	0.338kg	12	30*24*30	2.120
	ACH00888 Plastic Ceramic and Stone Pliers	0.170kg	12	30*24*30	4.200



Levelling System Protection Plate

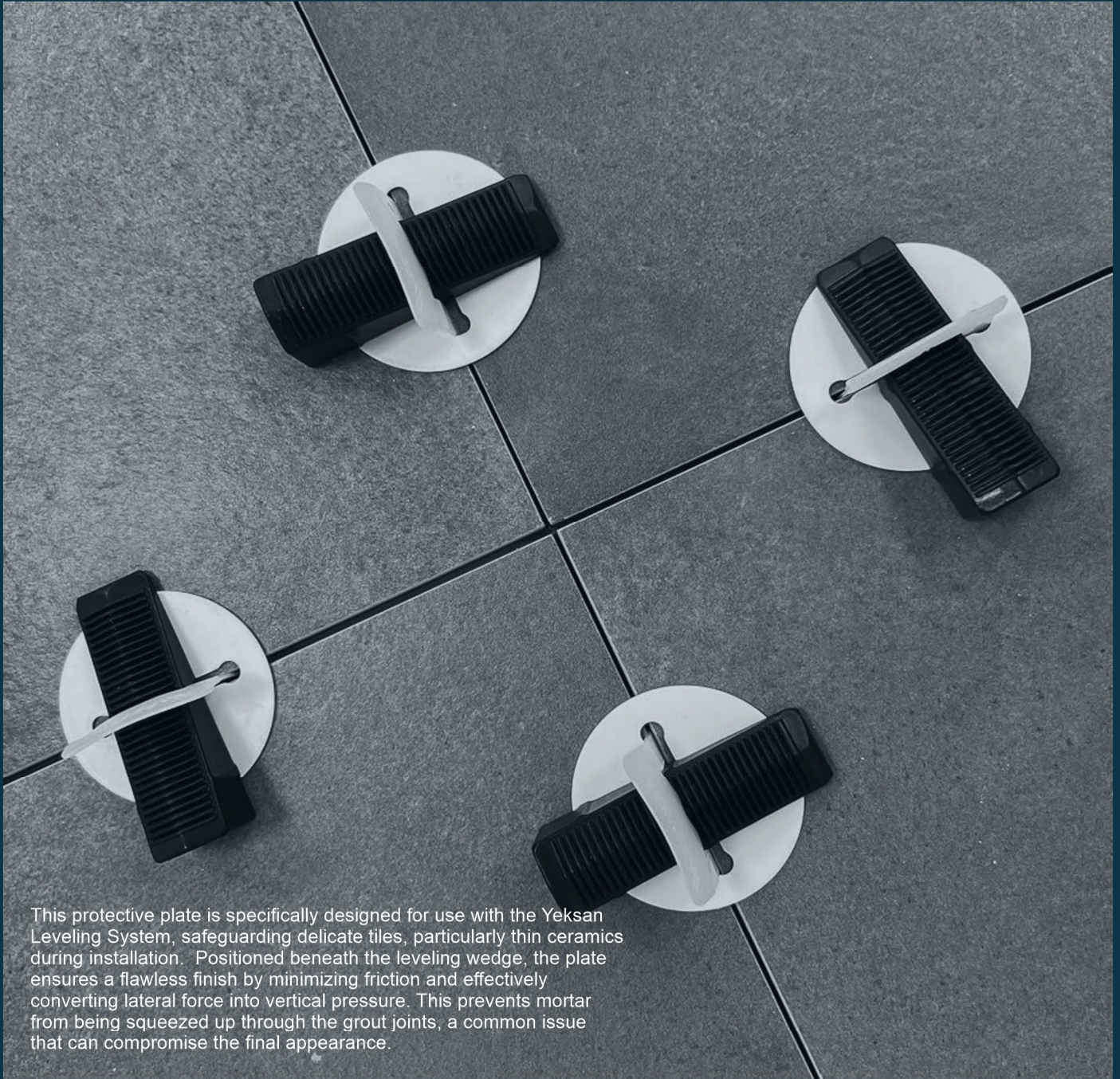

This protective plate is specifically designed for use with the Yeksan Levelling System, safeguarding delicate tiles, particularly thin ceramics during installation. Positioned beneath the leveling wedge, the plate ensures a flawless finish by minimizing friction and effectively converting lateral force into vertical pressure. This prevents mortar from being squeezed up through the grout joints, a common issue that can compromise the final appearance.

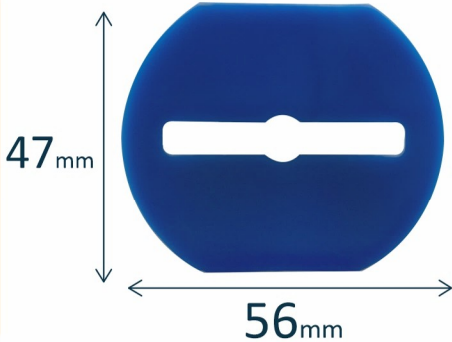

Ref.	Description	Units	Bags (per box)	Box (cm)	Weight (kg)
P00999	Levelling System Protection Plate	50	100	55×32×48	28.700



Spin Tile Leveling System

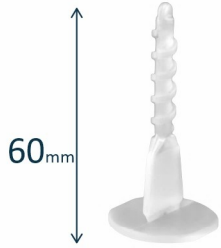



Ref.	Description	Size (mm)	Units	Bags (per box)	Box (cm)	Weight (kg)
GH00070	Spin Tile Leveling System	1	100	50	55×32×48	13.650
GH00085	Tile Leveling System Caps	1	100	36	55×32×48	14.500

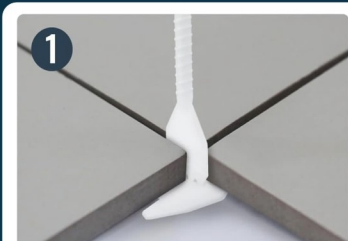

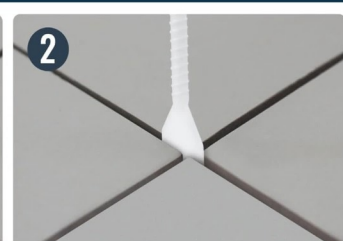
- 

1 Remove the remaining adhesive. Insert the base
- 

2 Glue the second tile
- 

3 Screw the cap and align the tile
- 



4 After 24 hours, knock off the cap in the direction shown in the picture

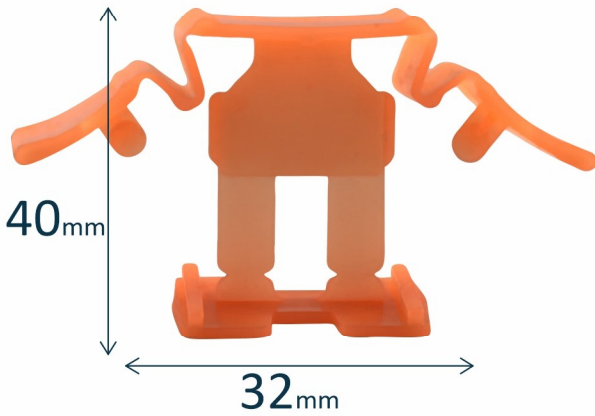

Butterfly Tile leveler

The butterfly tile leveler is a practical tool employed for precisely leveling ceramic tiles on floors, walls, and building facades. Available in various types, these levelers offer several advantages. Beyond ensuring proper tile alignment and consistent grout joint spacing, using butterfly levelers significantly increases installation speed and eliminates the need for tools like pliers and hammers.



Ref.	Size (mm)	Units 	Bags (per box) 	Box (cm) 	Weight (kg) 
Bf00789	1	50	36	55×32×48	10

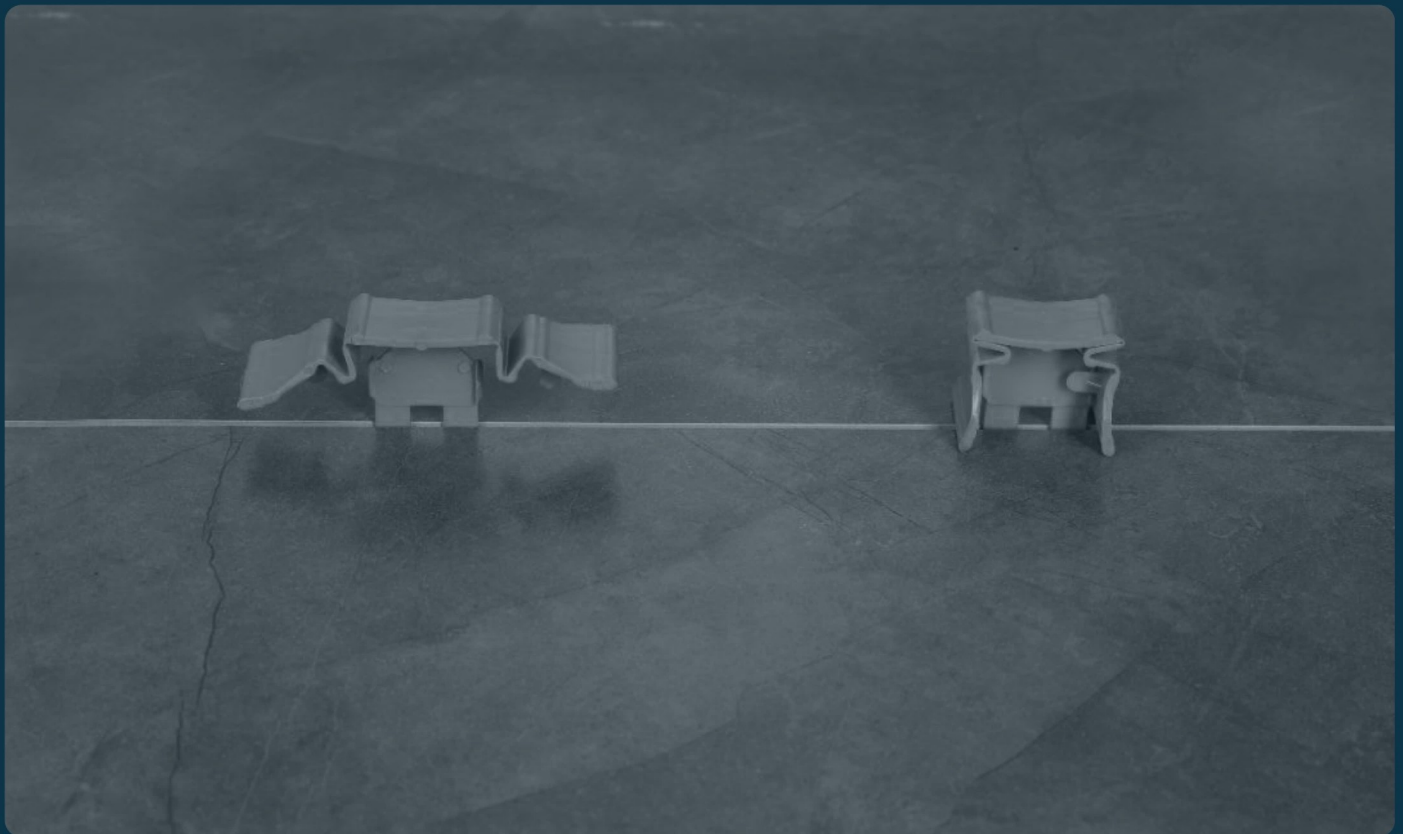



Tile Leveling System Plastic Spacer Cross

Tile Cross Spacer







Ref.	Description	mm(in)	Units	Bags (per box)	Box (cm)	Weight (kg)
S00300	Tile Cross Spacer	1	200	100	30*24*30	2.25
S00305	Tile Cross Spacer	1.5	200	100	30*24*30	2.700
S00301	Tile Cross Spacer	2	200	85	30*24*30	3.900
S00302	Tile Cross Spacer	3	200	45	30*24*30	4.430
S00303	Tile Cross Spacer	4	200	50	30*24*30	6
S00304	Tile Cross Spacer	5	200	33	30*24*30	5.600





Tile Leveling System Plastic Spacer Cross

Tile Cross Spacer

Ref.	Description	mm(in)	Units	Bags (per box)	Box (cm)	Weight (kg)
 S00305	Tile Cross Spacer	6	100	50	30*24*30	5.290
 S00306	Tile Cross Spacer	7	100	48	30*24*30	5.815
 S00307	Tile Cross Spacer	8	100	46	30*24*30	6.920
 S00308	Tile Cross Spacer	9	100	46	30*24*30	6.690
 S00309	Tile Cross Spacer	10	100	26	30*24*30	5.450
 S00310	Spacer	10	100	36	30*24*30	5.865
 S00311	Spacer	10	50	45	30*24*30	6.100

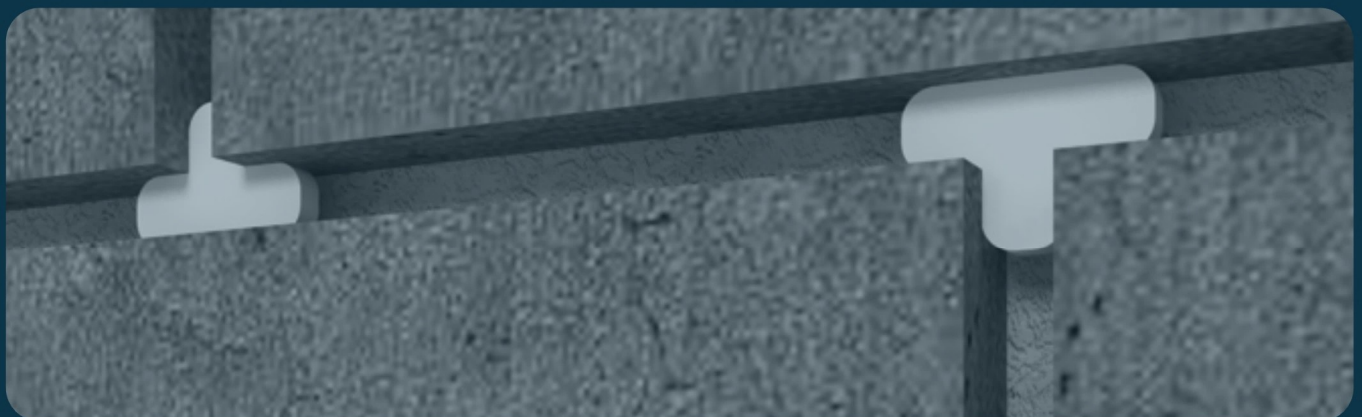



Levelling Bracket

This innovative leveling bracket simplifies and enhances the precision of tile installations, particularly when working with 90-degree angles in corners, projections, lintels, and similar areas. It also improves the final results in stepped installations. For situations with closely spaced corners, two brackets can be conveniently superimposed. The bracket's design incorporates spacious gaps to facilitate easy clip placement, and it includes a dedicated thickness piece to protect the tiles during installation.

Ref.	Description	Product dimensions (mm)	Units	Bags (per box)	Box (cm)	Weight (kg)	
	BR00660	Levelling Bracket	97*35	50	50	55×32×48	41.150

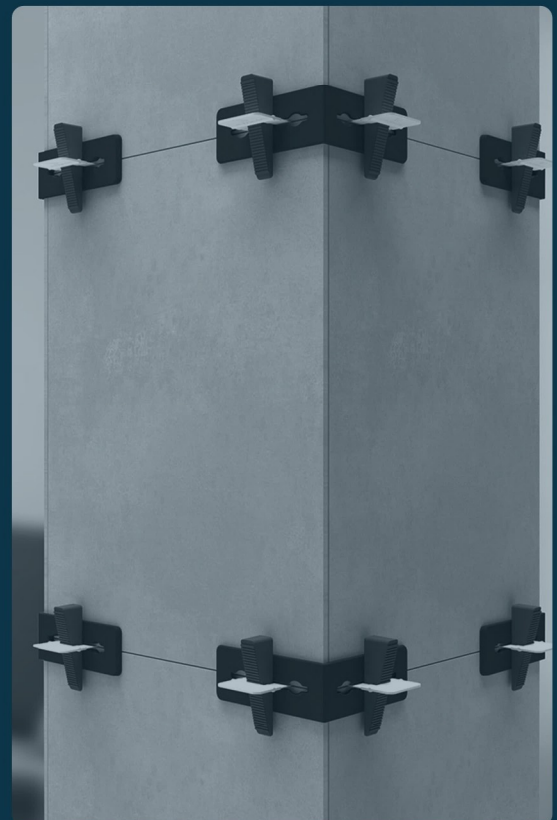
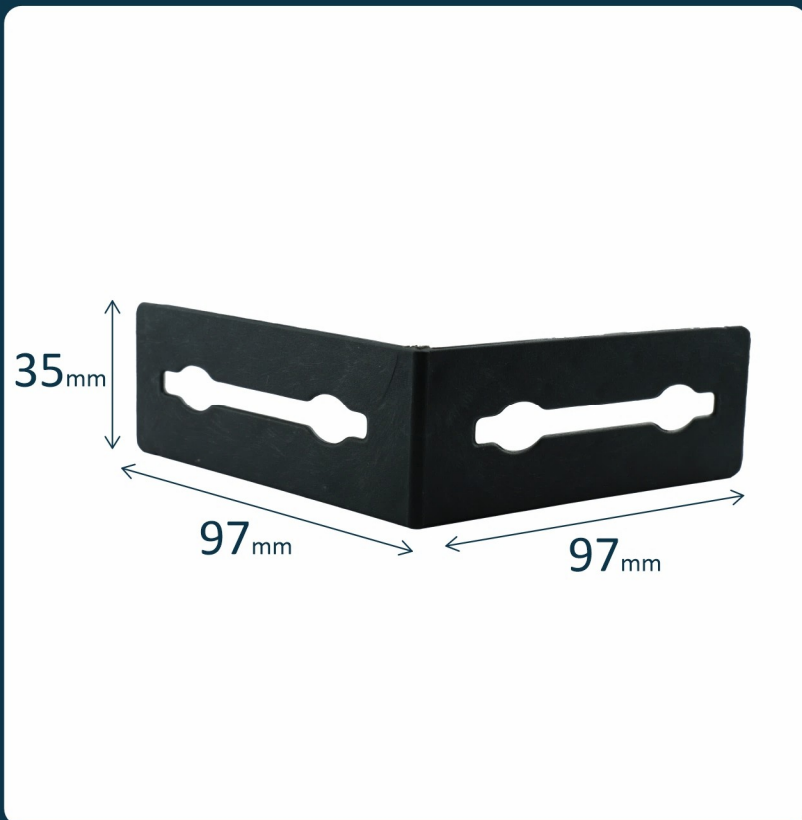



Stainless steel trowel

The YEKSAN Standard Notched Trowels represent the pinnacle of quality and performance for professional tile installers. These versatile tools excel in a wide range of tiling applications, from expansive floors, walls and delicate mosaic work. Each 300 x 125mm square notched trowel features a robust, yet flexible, hard tempered steel blade securely riveted to a lightweight aluminum alloy mounting, ensuring both durability and ease of use.

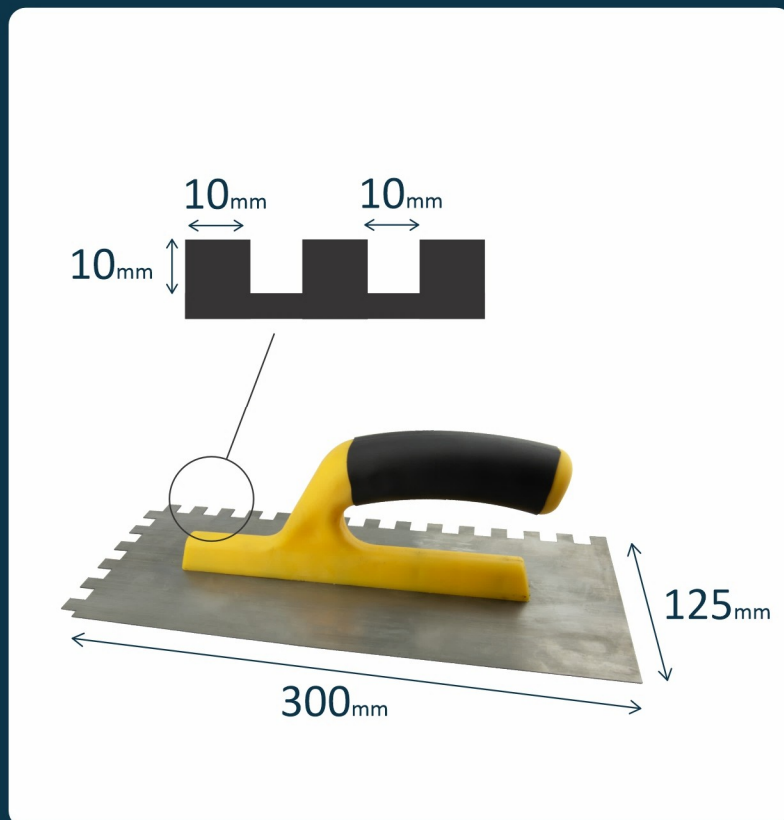

Ref.	Description	Teeth dimensions (mm)	Handle Material	Dimensions (mm)	Weight (gr)
 M00660	Square notch	10* 10	Rubber	300*125	365





Suction cups

A suction cup, also known as a sucker, is a device or object that uses the negative fluid pressure of air or water to adhere to nonporous surfaces, creating a partial vacuum.

Ref.	Description	Product dimensions (cm)	Blade material	Type	Loading Capacity	Power Source	Weight (gr)
	GH00070 Suction cups	11.5W * 17L	Rubber	Simple	30kg	hand powered	285
	GH00085 Suction cups	11.5W * 31L	Rubber	Double	60kg	hand powered	585



LEVEL UP YOUR WORK



WWW.YEKSANLEVEL.COM



YEKSANLEVEL



+98 9137798435

+98 9132550402

YEKSAN LEVELING SYSTEM